

# DisplayPac-OPR-17

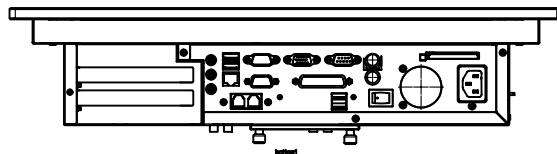
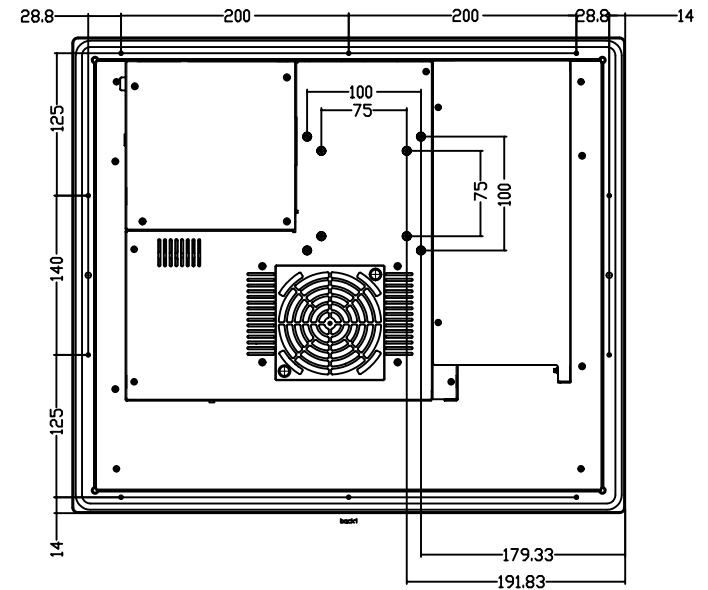
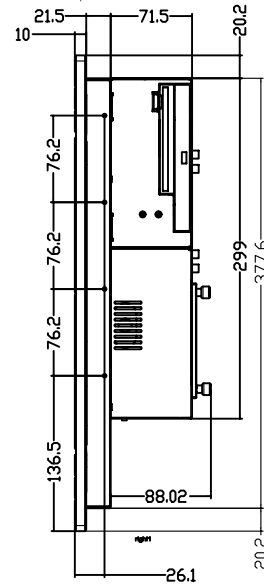
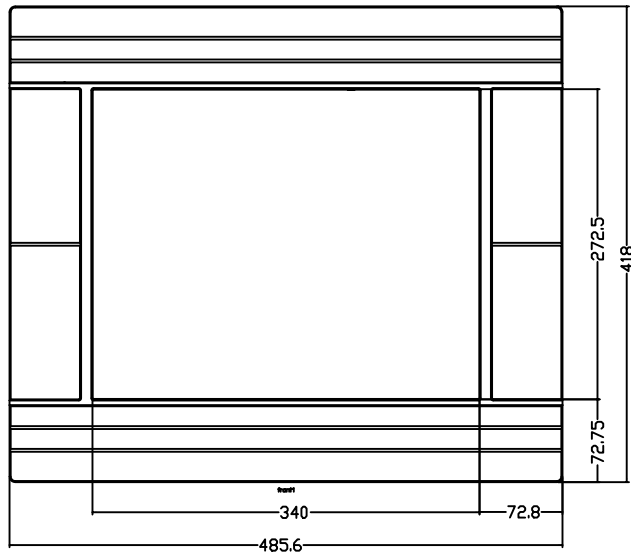
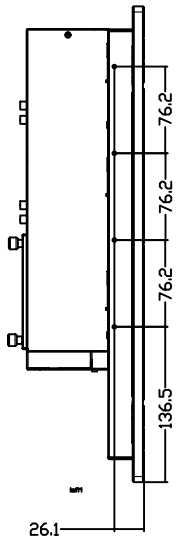
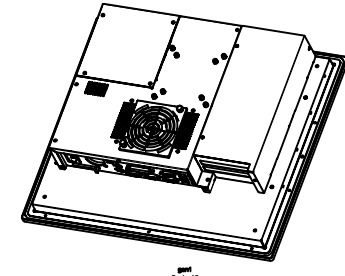
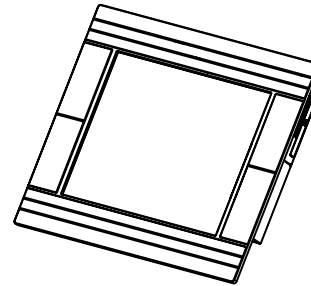
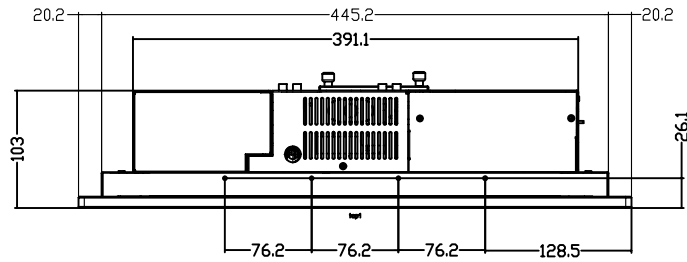

Measurements shown in mm  
All Dimensions are  $\pm 0.5$  mm

NOTE: This is a simplified drawing and some components are not marked in detail. Please contact your Applications Engineer for additional product information.