

DisplayPac-RPP8-D2550

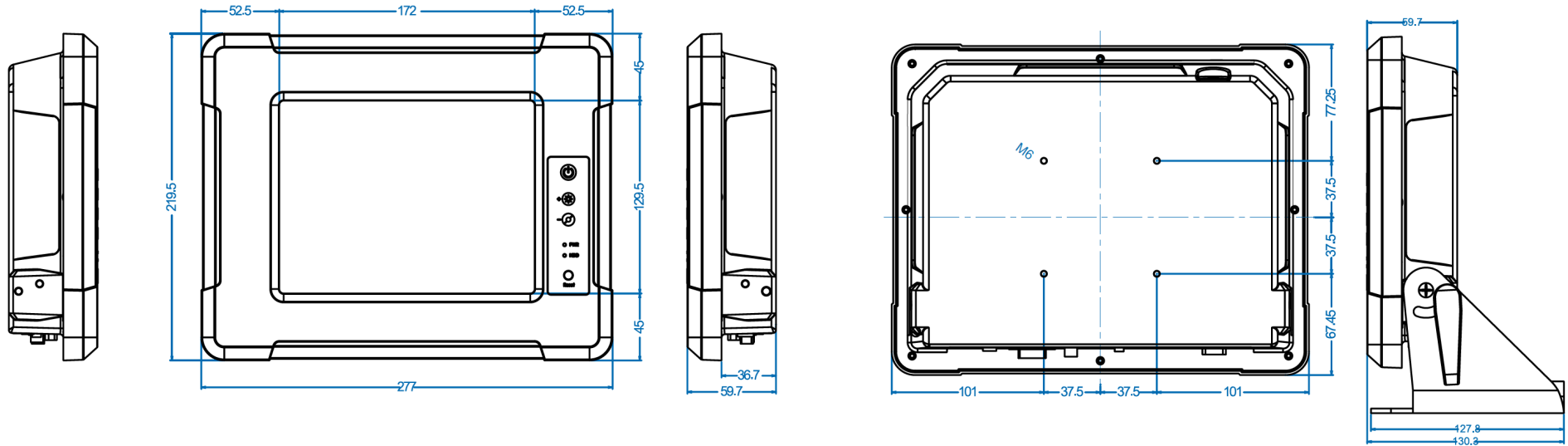

Measurements shown in mm
All Dimensions are ± 0.5 mm

NOTE: This is a simplified drawing and some components are not marked in detail. Please contact your Applications Engineer for additional product information.